

E552

E462







E422

E322

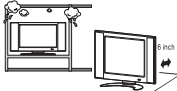
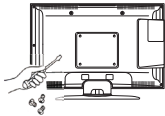
Index

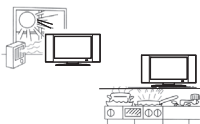
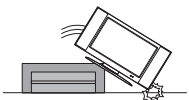
Precautions And Reminders	English-1
Important Safety Instructions	English-2
Safety Instructions	English-4
Important Information	English-5
Declaration Of Conformity	English-8
Preparation	English-10
Preparing Your LCD Display For Wall Mounting	English-10
Attaching the Base	English-11
Place The Display On A Solid Surface	English-11
Antenna Connection	English-11
Battery Installation and Replacement	English-12
Connect To The Power Source	English-13
Power On/Off Your New LCD Display	English-13
Source Connection Guide	English-14
RS-232C Port Specifications	English-16
Power Mode Status	English-16
Operating Instructions	English-17
Using The Side Panel Controls	English-17
Using The Remote Control	English-18
Picture Format for Each Input Source	English-19
Navigating The On-Screen Menu	English-20
Video Menu	English-20
Audio Menu	English-21
TV Menu	English-22
Setup Menu	English-22
Parental Menu	English-24
USB Menu	English-25
Tips	English-27
Care Of The Screen	English-27
Mobile Telephone Warning	English-27
End Of Life Directives	English-27
License Notice and Trademark Acknowledgement	English-27
Product Specification	English-28
Before Calling Service	English-30
Glossary	English-31
Limited Warranty	English-32
References	English-33

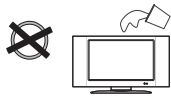
Precautions And Reminders

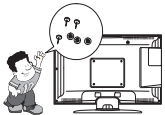
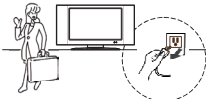
<p>Do not place the display in confined spaces or in a box when in use. Maintain ample ventilation for the display when in use.</p> 	<p>Do not open the display cabinet.</p> 	<p>Call a NEC certified service personnel for any internal service needed for your display.</p> 
<p>Keep the display away from direct sunlight, dust, humidity, and smoke.</p> 	<p>Unplug immediately if any foreign object is put in the display or if the display falls.</p> 	<p>Unplug immediately if there is a display malfunction such as a loss of audio/video, the presence of smoke, or a bad odor coming from the display.</p> 
<p>Unplug the AC cord from the AC outlet before cleaning. Do not use liquid cleaners or aerosol cleaners to clean the display.</p> 	<p>Do not place the display near water such as a bathtub, washbasin, sink, laundry tub, swimming pool, or a damp basement.</p> 	<p>Do not cover or block any vents or openings. Inadequate ventilation may shorten the life of the display and cause overheating.</p> 
<p>Place the unit on a sturdy, even surface.</p> 	<p>Do not insert any foreign objects into the display cabinet.</p> 	<p>Unplug the power cord from the outlet when the display is not in use for long periods of time (days).</p> 

 **Notice for Remote Controller**

<p>Avoid Liquids</p> 	<p>Avoid Aerosol Cleaners</p> 	<p>Avoid Dropping</p> 
--	---	---

Important Safety Instructions

Read before operating equipment

The lamps in this product contain mercury. Please dispose according to state, local or federal law.

Follow all warnings and instructions marked on this display.

1. Read these instructions.
2. Keep these instructions.
3. Heed all warnings.
4. Follow all instructions.
5. Do not use this apparatus near water.
6. Clean only with dry cloth.
7. Do not block any ventilation openings. Install in accordance with the manufacturer's instructions.
8. Do not install near any heat sources such as radiators, heat registers, stoves, or other apparatus (including amplifiers) that produce heat.
9. Do not defeat the safety purpose of the polarized or grounding-type plug. A polarized plug has two blades with one wider than the other. A grounding type plug has two blades and a third grounding prong. The wide blade or the third prong are provided for your safety. If the provided plug does not fit into your outlet, consult an electrician for replacement of the obsolete outlet.
10. Protect the power cord from being walked on or pinched particularly at plugs, convenience receptacles, and the point where they exit from the apparatus.
11. Only use attachments/accessories specified by the manufacturer.
12. Use only with the cart, stand, tripod, bracket, or table specified by the manufacturer, or sold with the apparatus. When a cart is used, use caution when moving the cart/apparatus combination to avoid injury from tip-over.
13. Unplug this apparatus during lightning storms or when unused for long periods of time.
14. Refer all servicing to qualified service personnel. Servicing is required when the apparatus has been damaged in any way, such as power-supply cord or plug is damaged, liquid has been spilled or objects have fallen into the apparatus, the apparatus has been exposed to rain or moisture, does not operate normally, or has been dropped.
15. The display complies with the recommended safety standards for stability. Do not put excessive force on the front or top of



the cabinet. This could cause the product to tip over and cause damage and/or personal injury.

16. If monitor or glass is broken, do not come in contact with the liquid crystal and handle with care.
17. Follow instructions for wall, shelf or ceiling mounting as recommended by the manufacturer.
18. An outdoor antenna should not be located near overhead power lines or any electrical circuits.
19. If an outside antenna is connected to the receiver, confirm that the antenna system is grounded to protect against voltage surges and built up static charges. Section 810 of the National Electric Code, ANSI/NFPA No. 70-1984, provides information with respect to proper grounding for the mast and supporting structure, grounding of the lead-in wire to an antenna discharge unit, size of grounding connectors, location of antenna discharge unit, connection to grounding electrodes and requirements for the grounding electrode.

NOTE: To the display system installer: This reminder is provided to call attention to Article 820-44 of the National Electric Code that provides guidelines for proper grounding and, in particular, specifies that the cable ground shall be connected to the grounding system of the facility, as reasonably close to the point of cable entry as possible

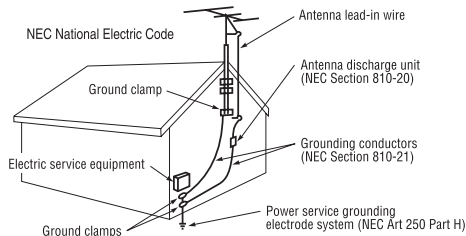

Power source

This LCD display operates on 120 volts 60 Hz, AC current. Insert the power cord into a 120 volts 60 Hz outlet. The mains plug is used as the disconnect device and shall remain readily operable.

To prevent electric shock from the display, do not use with an extension cord, receptacle, or other outlet unless the blades and ground terminal can be fully inserted to prevent blade exposure.

Never connect the LCD display to 50 Hz, direct current, or anything other than the specified voltage.

CAUTION: Never remove the back cover of the LCD display as this can expose you to very high voltages and other hazards. If the display does not operate properly, unplug the LCD display and call your authorized dealer or service center.

Adjust only those controls that are covered in the instructions, as improper changes or modifications not expressly approved by NEC could void the user's warranty.

Safety Instructions

FCC STATEMENT

This equipment has been tested and found to comply with the limits for a Class B digital device, pursuant to Part 15 of the FCC Rule. These limits are designed to provide reasonable protection against harmful interference in a residential installation. This equipment generates, uses and can radiate radio frequency energy and, if not installed and used in accordance with these instructions, may cause harmful interference to radio communications. However, there is no guarantee that interference will not occur in a particular installation. If this equipment does cause harmful interference to radio or television reception, which can be determined by turning the equipment off and on, the user is encourage to try to correct the interference by one or more of the following measures:

1. Reorient or relocate the receiving antenna.
2. Increase the separation between the equipment and receiver.
3. Connect the equipment into an outlet on a circuit different from that to which the receiver is connected.
4. Consult the dealer or an experienced radio/display technician for help.

This device complies with Part 15 of the FCC Rules. Operation is subject to the following two conditions:

1. This device may not cause harmful interference.
2. This device must accept any interference received, including interference that may cause undesired operation.



FCC CAUTION





To assure continued compliance and possible undesirable interference, ferrite cores may be used when connecting this LCD display to video equipment; and maintain at least 400mm spacing to other peripheral device.

CANADIAN NOTICE

This Class B digital apparatus complies with Canadian ICES-003

Important Information

	WARNING	
<p>TO PREVENT FIRE OR SHOCK HAZARDS, DO NOT EXPOSE THIS UNIT TO RAIN OR MOISTURE. ALSO, DO NOT USE THIS UNIT'S POLARIZED PLUG WITH AN EXTENSION CORD RECEPTACLE OR OTHER OUTLETS UNLESS THE PRONGS CAN BE FULLY INSERTED.</p> <p>REFRAIN FROM OPENING THE CABINET AS THERE ARE HIGH VOLTAGE COMPONENTS INSIDE.</p> <p>REFER SERVICING TO QUALIFIED SERVICE PERSONNEL.</p>		

	CAUTION	
<p>CAUTION: TO REDUCE THE RISK OF ELECTRIC SHOCK, MAKE SURE POWER CORD IS UNPLUGGED FROM WALL SOCKET. TO FULLY DISENGAGE THE POWER TO THE UNIT, PLEASE DISCONNECT THE POWER CORD FROM THE AC OUTLET. DO NOT REMOVE COVER (OR BACK). NO USER SERVICEABLE PARTS INSIDE. REFER SERVICING TO QUALIFIED SERVICE PERSONNEL.</p>		
	<p>This symbol warns user that uninsulated voltage within the unit may have sufficient magnitude to cause electric shock. Therefore, it is dangerous to make any kind of contact with any part inside this unit.</p>	
	<p>This symbol alerts the user that important literature concerning the operation and maintenance of this unit has been included. Therefore, it should be read carefully in order to avoid any problems.</p>	

CAUTION: Please use the power cord provided with this display in accordance with the table below. If a power cord is not supplied with this equipment, please contact your supplier.

Plug Type	Plug Shape	Region	Voltage
North America		U.S.A./Canada	AC 120 V

Apparatus shall not be exposed to dripping or splashing and no objects filled with liquids, such as vases, shall be placed on the apparatus.

The Class I apparatus shall be connected to a mains socket outlet with a protective grounding connection.

Batteries installed warning

Caution - Danger of explosion if batteries are incorrectly replaced. Replace only with the same or equivalent type. The batteries shall not be exposed to excessive heat such as sunshine, fire or the like.

CAUTION:

These servicing instructions are for use by qualified service personnel only. To reduce the risk of electric shock, do not perform any servicing other than that contained in the operating instructions unless you are qualified to do so.

Ventilation

The slots and openings in the TV are provided for necessary ventilation. To ensure reliable operation of the TV and to protect it from overheating, these slots and openings must never be blocked or covered.

Unless proper ventilation is provided, the TV may gather dust and get dirty. For proper ventilation, observe the following:

- Do not install the TV face up, down or sideways.
- Do not install the TV turned over or upside down.
- Never cover the slots and openings with a cloth or other materials.
- Never block the slots and openings by placing the TV on a bed, sofa, rug or other similar surface.
- Never place the TV in a confined space, such as a bookcase or built-in cabinet, unless proper ventilation is provided.

Leave some space around the TV set as shown below. Otherwise, air-circulation may be inadequate and will cause overheating, which may cause a fire or damage to the TV set.

Install on the wall

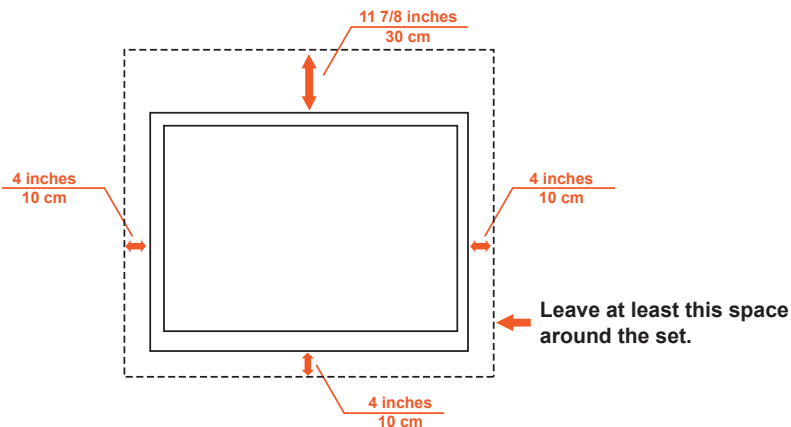

Installed with stand

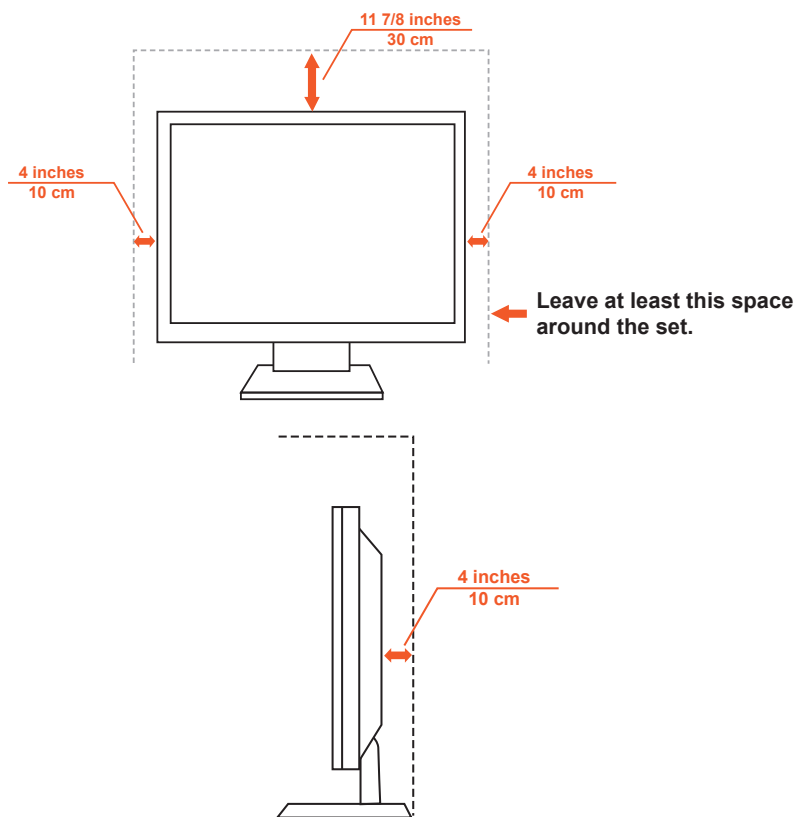

Never install the TV set where Air circulation is blocked.

Objects and ventilation holes

Never push objects of any kind into the TV through the cabinet slots as they may touch dangerous voltage points or short out parts that could result in a fire or an electric shock. Do not place any objects on the TV.

Declaration Of Conformity

This device complies with Part 15 of FCC Rules. Operation is subject to the following two conditions. (1) This device may not cause harmful interference, and (2) this device must accept any interference received, including interference that may cause undesired operation.

U.S. Responsible Party:	NEC Display Solutions of America, Inc.
Address:	500 Park Boulevard, Suite 1100 Itasca, Illinois 60143
Tel. No.:	(630) 467-3000

Type of Product:	Digital Signage Display
Equipment Classification:	Class B Peripheral
Model:	E552(L550UQ) E462(L460UR) E422(L420UT) E322(L320UU)



*We hereby declare that the equipment specified above
conforms to the technical standards as specified in the FCC Rules.*

Canadian Department of Communications Compliance Statement

DOC: This Class B digital apparatus meets all requirements of the Canadian Interference-Causing Equipment Regulations.

C-UL: Bears the C-UL Mark and is in compliance with Canadian Safety Regulations according to CAN/CSA C22.2 No. 60065-03.

FCC Information:

1. Use the attached specified cables with the E322/E422/E462/E552 color monitor so as not to interfere with radio and television reception.
 - (1) Please use the supplied power cord or equivalent to ensure FCC compliance.
 - (2) Please use the supplied shielded video signal cable, Mini D-SUB 15 pin to Mini D-SUB 15 pin.
2. This equipment has been tested and found to abide by the limits of a Class B digital device, pursuant to part 15 of the FCC Rules. These limits are intended to provide reasonable security against harmful interference in a residential deployment. This equipment generates, uses, and can radiate radio frequency energy, and, if not installed and used in accordance with the instructions, may cause harmful interference to radio communications. However, there is no guarantee that interference will not occur in a certain installation. If this equipment does cause damaging interference to radio or television reception, which can be determined by powering the equipment on and off, the user is encouraged to attempt correcting the interference by one or more of the following procedures:

3. following procedures:
- Reorient or relocate the receiving display.
 - Increase the separation between the equipment and display.
 - Connect the equipment into a different outlet than the receiver.
 - Consult your dealer or an experienced radio/display technician for assistance.

If necessary, the user should contact the dealer or an experienced radio/television technician for additional suggestions. The user may find the following booklet, prepared by the Federal Communications Commission, helpful: "How to Identify and Resolve Radio-display Interference Problems." This booklet is available from the U.S. Government Printing Office, Washington, D.C., 20402, Stock No. 004-000-00345-4.

Windows is a registered trademark of Microsoft Corporation.

NEC is a registered trademark of NEC Corporation.

All other brands and product names are trademarks or registered trademarks of their respective owners.



HDMI, the HDMI logo and High-Definition Multimedia Interface are trademarks or registered trademarks of HDMI Licensing LLC in the United States and other countries.

Preparation

IMPORTANT: Do not apply pressure to the screen display area which may compromise the integrity of the display. The manufacturer's warranty does not cover user abuse or improper installations.

Preparing Your LCD Display For Wall Mounting

We suggest that you keep your display at least 2.36 inches (60 mm) from the wall to prevent cable interference. Before mounting your display on the wall, you need to remove the base. For your safety, only mount with a UL listed wall mount bracket that supports the weight of the display. (Please see page 28 .) To attach a wall mount bracket to your display:

E322 / E422 / E462

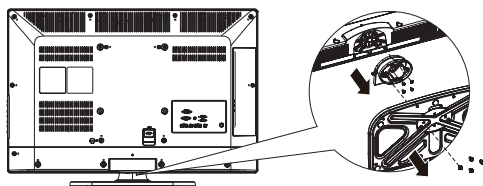

E552

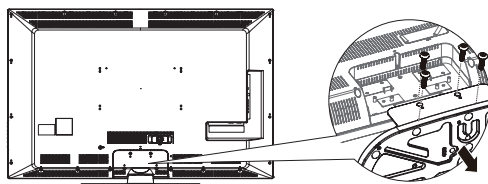

screen size (inches)	required pitch (mm)	require mounting bolts
32	200 x 200	4 x M6
42	400 x 200	4 x M6
46	400 x 200	4 x M6
55	400 x 200	4 x M6

1. E322/E422/E462: Loosen the screws on the bottom of the stand and base.
E552: Loosen the screws on the back of the stand-base.
2. Remove the stand base from your display.
3. Secure the wall mount bracket to the back of your display using four M6 screws.

Note: Wall mounting solution is not included with the unit and is sold separately. Contact your NEC representative for details.

Attaching the Base

E322 / E422 / E462

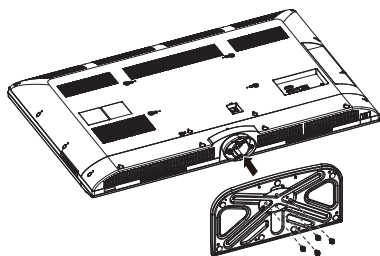

E552

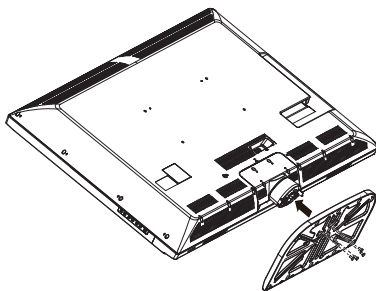

1. Place the display face down on a soft and flat surface to prevent scratching and damage.
2. Carefully align the base to the stand and fasten the screws with a cross-head screwdriver.

CAUTION: The base of the stand is very heavy. Install with care to avoid injury such as dropping the base onto one's foot.

Place The Display On A Solid Surface

Ensure that the LCD display is placed in a position to allow free flow of air. Do not cover the ventilation openings on the back cover. Do not place the display near any open flames. Do not allow the display to be placed in an environment where it can be exposed to heat, direct sunlight, or rain and water. Do not expose the equipment to any liquid.

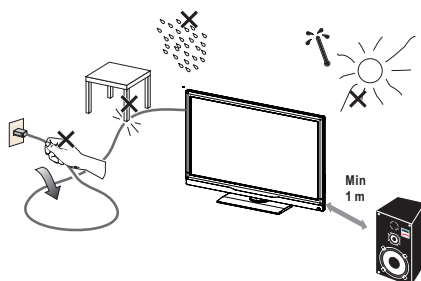

Antenna Connection

Unless your LCD display is connected to a cable TV system or to a centralized antenna system, a good outdoor color TV antenna is recommended for best television performance. However, if you are located in an exceptionally good signal area that is free from interference and multiple image ghosts, an indoor antenna may be sufficient.

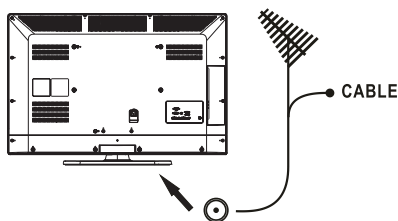

When using a 75-Ohm coaxial cable system, connect the CATV coaxial cable to the AIR/CABLE (75-Ohm) terminal. Or if you have an antenna, connect the coaxial cable to the same AIR/CABLE terminal.

Battery Installation and Replacement

The remote control is powered by two 1.5V AAA batteries. To install or replace batteries:

1. Open the battery cover of the remote control by pushing and pulling it in the direction of the arrow.
2. Insert two new “AAA” size batteries for the remote control. When replacing old batteries, push them towards the springs and lift them out.
3. Match the batteries to the (+) and (-) marks in the battery compartment.
4. Insert the bottom of the battery, the (-) side, into the battery compartment first, push towards the springs and insert the top of the battery, the (+) side, into place. Do not force the battery into the battery compartment.
5. Close the battery cover making sure the tabs rest in the corresponding holes and push down the cover until it clicks shut.

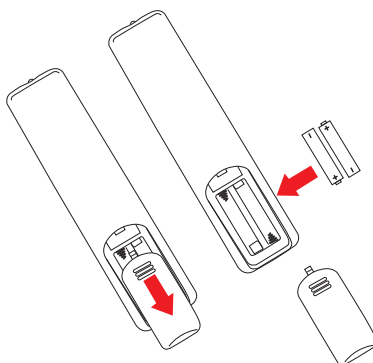

CAUTION: Incorrect usage of batteries can result in leaks or bursting.

NEC recommends the following battery use:

- Do not mix battery brands.
- Do not combine new and old batteries. This can shorten the battery life or cause liquid leakage of the batteries.
- Remove dead batteries immediately to prevent battery acid from leaking into the battery compartment.
- Do not touch exposed battery acid as it may injure skin.
- Remove the batteries if you do not intend to use the remote control for a long period of time.

Connect To The Power Source

The display should be installed close to an easily accessible power outlet. Fully insert the prongs into the power outlet socket. A loose connection may cause image degradation.

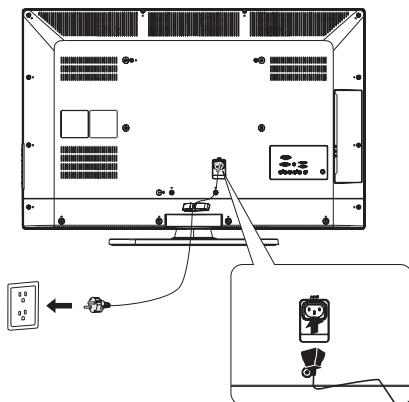

If there is power to the display, the front LED at the bottom of the display will be either blue or red. A blue LED means the display is powered on. A red LED means the display is in standby mode.

Power On/Off Your New LCD Display

Press the power key on the remote control or press the power button located on the side of the display. The display will power on.

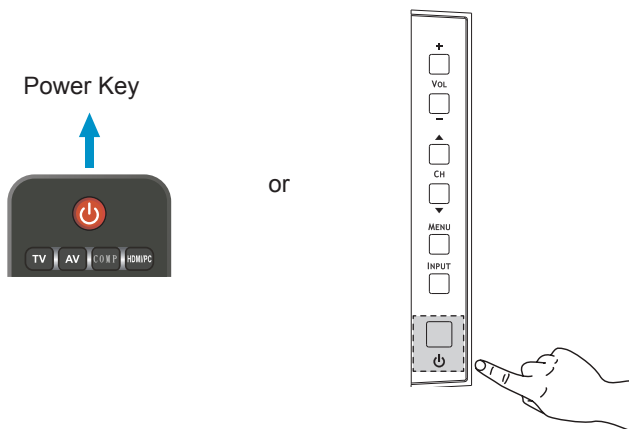

Source Connection Guide

E322/E422/E462

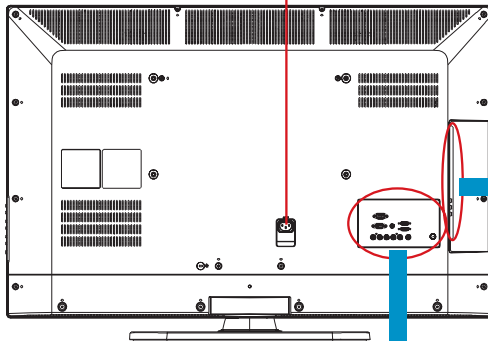

E322/E462

E422

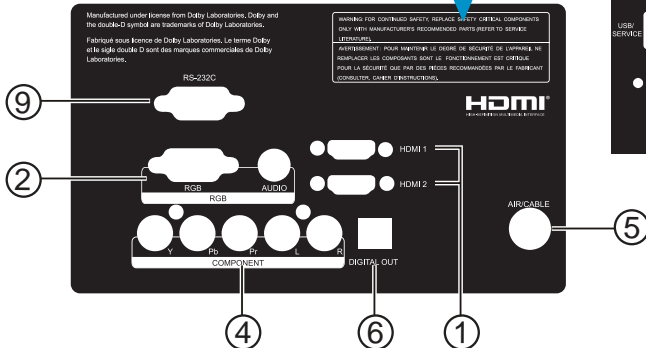
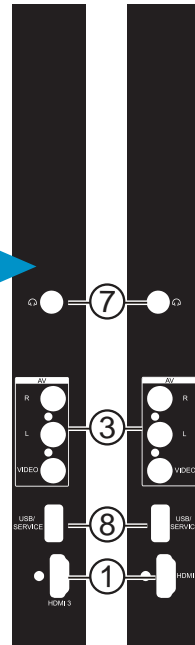

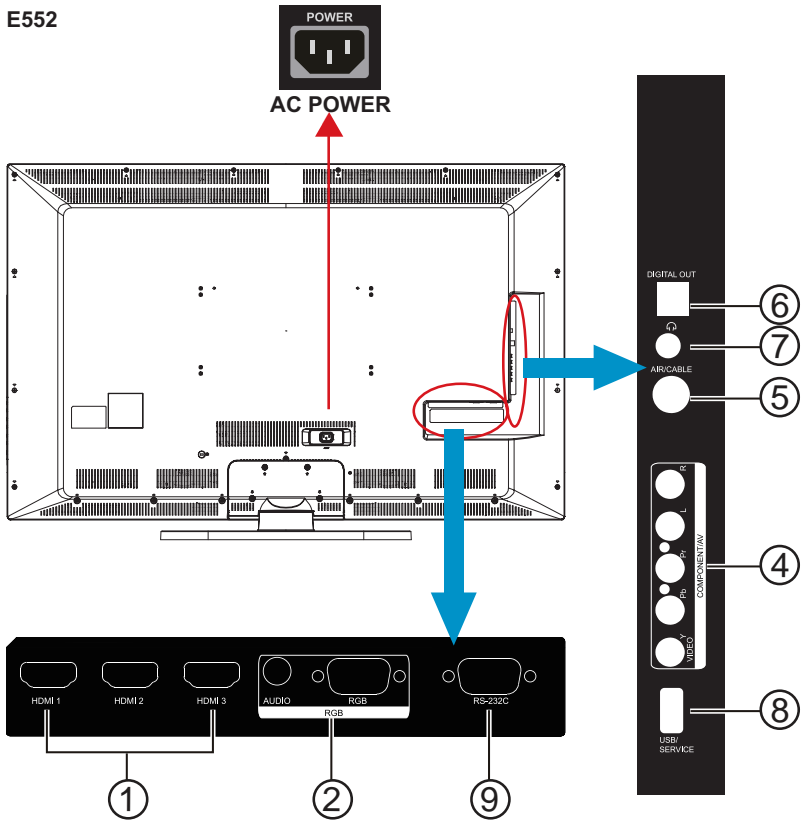

1. **HDMI** – Connect the primary source for digital video such as a DVD multimedia player or set top box through this all digital connector.
2. **RGB/AUDIO** – Connect the video and audio cables from a computer here.
3. **AV** – Connect the primary source for composite video devices, such as a VCR or video game. Use the white and red connectors to connect the external audio from the same source.
4. **COMPONENT (Y-PbPr with Audio L/R)** – Connect the primary source for component video devices such as a DVD Player or set top box here. Use red for Pr, blue for Pb, green for Y, red for right audio (R) and white for left audio (L) inputs.
5. **AIR/CABLE** – Connect to an antenna or digital cable (out-of-the-wall, not from Cable Box) for the digital tuner.
6. **DIGITAL OUT** – When a digital audio signal is associated with the input selected for viewing, the digital audio will be available on this DIGITAL OUT connection to your home theater system.
7. **Earphone Output** – Connect to the headphones. When the headphone is inserted to the plug, all the speakers will be muted.

8. **USB/SERVICE** – Insert USB storage device to view photos and listen to the music. /This USB slot is for future software upgrades.
9. **RS-232C** – Input from external equipment such as a PC or AV control system in order to control RS-232C functions.

Once your AV device is connected, press the Source button on the remote control to select the relevant source to view. (ex: Press COMP button to select “Component” if you have connected a source to the Component input.)

RS-232C Port Specifications

PC control of the TV

Attach an RS-232C cable cross-type (commercially available) to the supplied Din/D-Sub RS-232C for the connections.

Note: This operation system should be used by a person who is accustomed to using computers.

Communication conditions

Set the RS-232C communication settings on the PC to match the TV's communication conditions.

The TV's communication settings are as follows:

Baud rate:	9,600 bps
Data length:	8 bits
Parity bit:	None
Stop bit:	1 bit
Flow control:	None

Communication procedure

Send the control commands from the PC via the RS- 232C connector.

The TV operates according to the received command and sends a response message to the PC.

Do not send multiple commands at the same time. Wait until the PC receives the response before sending the next command.

Power Mode Status

Mode	LED Status	VGA	AV	Component	HDMI 1-3	TV
On	Blue	v	v	v	v	v
Power Saving	Purple	v	-	-	-	-
Standby	Red	v	v	v	v	v

Power saving support automatically power on when signal appear.

Standby to power on by touch up remote or keypad power button.

Operating Instructions

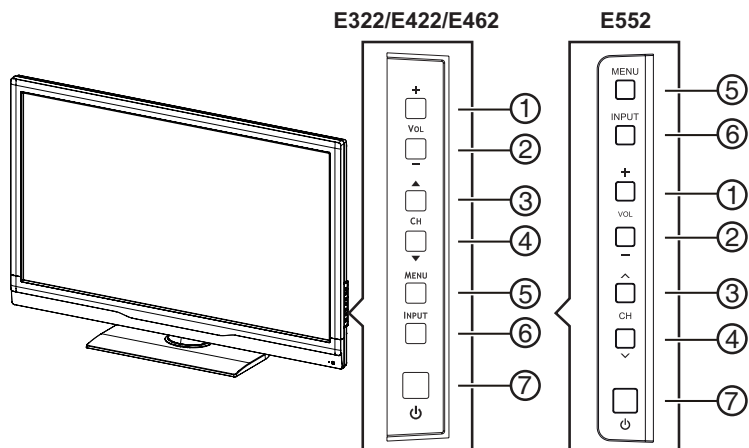

Using The Side Panel Controls

1.	VOL +	Press to increase the volume. Press this key to shift Right in the OSD menu.
2.	VOL -	Press to decrease the volume. Press this key to shift Left in the OSD menu.
3.	CH ▲ / ^	Press to increase the channel number. Press this key to shift up in the OSD menu.
4.	CH ▼ / v	Press to decrease the channel number. Press this key to shift down in the OSD menu.
5.	MENU	Press to open or exit the OSD (On-Screen Display) menu.
6.	INPUT	Press to select the input source.
7.	POWER	Press to turn on / off (standby) the display.

Using The Remote Control

Power

Press to turn On/Off (standby) the power. (Note: To completely turn off the power, unplug the AC cord from the power outlet.)

TV

Press to choose ATSC/NTSC tuner source mode.

AV

Press to choose Composite source mode.

COMP

Press to choose Component source mode.

HDMI/PC

Press repeatedly to choose PC IN or HDMI source mode.

0 – 9 / - number

Press to enter the tuner channel number to select channel (Press '-' to choose the sub-channel).

PRE CH

Press to display the previous channel.

Source

Press repeatedly to choose the various input sources.

Mute

Switch the sound On/Off.

VOL+ / VOL-

Press + or - to adjust the volume.

CH+ / CH-

Press + or - to browse through the channels.

Exit

Press to exit the OSD menu.

Display

Press to show the information about the input source and tuner channel.



FAV

Press to display the Favorite List.

Menu

Press to open the OSD menu.

▲, ▼, ◀, ▶, OK

Press to select or confirm the various function items on the menu.

Color buttons

Follow the on-screen instruction to operate.

EPG

Press to display the Electronic Program Guide in TV mode. It shows the current channel name, program name, time, rating, and summary, depending on the information provided by the broadcaster.

Freeze

Press to freeze the displayed picture.

MTS

Press to activate the NTSC tuner sounds such as Stereo, SAP, Mono-tone, and languages of the digital tuner.

Wide

Press to choose the display aspect ratio: Wide Screen/4:3/Panorama/Zoom/Automatic/Dot by Dot. (Ratio availability varies by video inputs. Refer to the Picture Format Table below for details.)

Picture

Press to choose the picture mode: Sports/Standard/Movie/Power Saver/User.

Audio

Press to choose sound mode: Rock/Pop/Live/Dance/Techno/Classic/Soft/Off.

Ch-List

Press to display the Channel List.

C.C.

Press to activate the Closed Caption.

Picture Format for Each Input Source

Input Signal		Aspect					
		Automatic	Wide Screen	4:3	Panorama	Zoom	Dot by Dot
ATV		Yes	Yes	Yes	Yes	Yes	No
DTV	SD	Yes	Yes	Yes	Yes	Yes	No
	HD	Yes	Yes	No	No	Yes	No
Composite		Yes	Yes	Yes	Yes	Yes	No
Component	480i, 480p	Yes	Yes	Yes	Yes	Yes	No
	720p, 1080i, 1080p	Yes	Yes	No	No	Yes	No
PC IN	640x480, 800x600, 1024x768, 1280x1024	No	Yes	Yes	No	No	Yes
	720x400, 1280x720, 1280x800, 1440x900, 1680x1050	No	Yes	No	No	No	Yes
	1366x768 (For E322 model)	No	Yes	No	No	No	Yes
	1920x1080	No	Yes	No	No	No	Yes
HDMI 1 HDMI 2 HDMI 3	480i, 480p	Yes	Yes	Yes	Yes	Yes	No
	720p, 1080i, 1080p	Yes	Yes	No	No	Yes	No
	640x480, 800x600, 1024x768, 1280x1024	Yes	Yes	Yes	No	Yes	No
	720x400, 1440x900, 1280x720, 1280x800, 1680x1050	Yes	Yes	No	No	Yes	No
	1366x768 (For E322 model)	Yes	Yes	No	No	Yes	No
	1920x1080	Yes	Yes	No	No	Yes	No

Navigating The On-Screen Menu

Press the Menu button to display and Exit to close the main menu.

Use the Navigation Ring to navigate, select, adjust or confirm an item on the OSD (On Screen Display) menu.

Note: Some features may only be available in a particular source mode.

Video Menu

This menu adjusts video items.

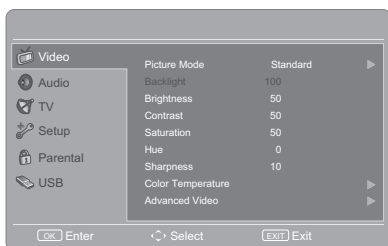

1. Picture Mode

Adjust the picture appearance by choosing one of the preset picture modes: Standard, Movie, Power Saver, User, Sports.

2. Backlight

Adjust the backlight strength from 0 – 100. Only available when the Adaptive Backlight is set to "Off".

3. Brightness

Control the display brightness from 0 – 100.

4. Contrast

Control the display contrast from 0 – 100.

5. Saturation

Adjust the color intensity from 0 – 100.

6. Hue

Adjust the skin tones from -50 – 50.

7. Sharpness

Control the display sharpness from 0 – 20.

8. Color Temperature

Four color temperature modes (Warm / Normal / Cool / User).

9. Advanced Video

Provide various advanced functions for optimizing the picture quality.

[DNR]

DNR (Digital Noise Reduction) enables you to reduce the noise effect without degrading picture quality (Off/Low/Medium/Strong).

[MPEG NR]

Reduce MPEG grained noise from receiving signal.

[Adaptive Luma Control]

Automatically adjusts the brightness and contrast after analyzing the input signal. This function enriches the colors and the depth of the picture.

[Flesh Tone]

Adjust the skin color to be more natural.

[Blue Stretch]

Level down the brightest part of the screen to reduce the saturation.

[HDMI Mode]

Only available when HDMI device is connected. Select from Auto, Graphic, or Video.

Note:

- **Auto:** The input timing is set to Video or Graphic mode automatically.
- **Graphic:** The input timing is set to Graphic mode (PC). The image is full scan.

- **Video:** The input timing is set to Video mode. The image is over scan.
- **HDMI Mode** is only workable for HDMI Video & Progressive timing as followed: 1920x1080p, 1280x720p, 720x480p, 720x576p.

[Adaptive Backlight]

Optimize the backlighting levels for dark scenes automatically.

10. **VGA**

The VGA adjustment is only available when the TV is receiving a computer signal.

[Auto Adjust]

Adjust the PC timing to fit full screen display automatically.

[H.Position]

Adjust the horizontal positioning.

[V.Position]

Adjust the vertical positioning.

[Phase]

Adjust the Phase frequency.

[Clock]

Adjust the Clock frequency.

Audio Menu

The Audio menu provides an audio adjustment for user to modify the audio setting.

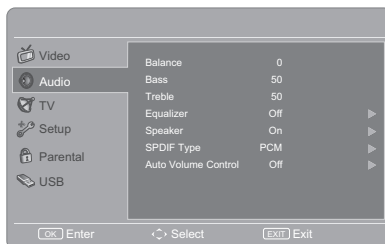

1. **Balance**
Audio balance adjustment, the tuning range is -50 – 50.
2. **Bass**
Control the bass tone from 0 – 100. (The default of 50 is enabled)
3. **Treble**
Control the treble tone from 0 – 100. (The default of 50 is enabled)
4. **Equalizer**
Select the preset audio mode from Off, Rock, Pop, Live, Dance, Techno, Classic, or Soft.
5. **Speaker**
Turn on/off the internal speakers. The digital audio output signals and earphone output signals will not be turned off even though the speaker is off.
6. **SPDIF Type**
Digital audio output format. Select from Dolby Digital or PCM.
7. **Auto Volume Control**
Automatically adjust the volume to be consistent across programs and channels.

TV Menu

The channel menu sets your signal source options.

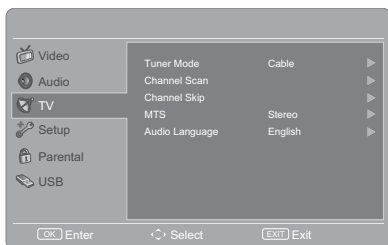

1. Tuner Mode

Select TV source signal from the air (antenna) or cable (CATV).

2. Channel Scan

Automatically scans all NTSC/ATSC tuner channels and then stores them in the channel table.

3. Channel Skip

Skip the selected channel to prevent certain programs from being watched by pressing CH+/CH- buttons on the remote control.

Note:

- The skipped channel can be access by pressing number buttons.

4. MTS

Select the audio mode from Stereo, SAP, or Mono.

5. Audio Language

Swap between main and alternative language when it is available in digital channel.

Setup Menu

The Setup menu in TV mode is shown below. According to various requirements in different source modes, certain features could be hidden (disabled) on the menu.

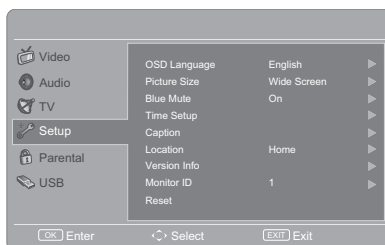

1. OSD Language

Select the menu display language. (English/Español/Français)

2. Picture Size

Change the display aspect ratio: Wide Screen/4:3/Panorama/Zoom/Automatic. (Ratio availability varies by video inputs. Refer to the Picture Format Table on page 19)

3. Blue Mute

When no signal is received, the screen will turn blue and the sound will be muted.

4. Time Setup

Set current time.

[Time Zone]

Set your current location.

[Time]

- **Auto Synchronization:** Set Auto Synchronization to "On" to set the time automatically based on the broadcaster, or set to "Off" to set the date and time manually.
- **Timer:** Set the timer to switch the TV on/off automatically at a preset time.

[Sleep Timer]

Set a time when the TV switches to standby automatically.

[Auto Sleep]

Set the TV to put itself to sleep after it has not been used for 1, 2, or 5 hours.

5. **Caption****[Analog Closed Caption]**

Select an analog closed caption option. (CC 1-4 / TEXT 1-4)

[Digital Closed Caption]

This function sets captions for digital programs and sets available languages.

[Digital Caption Style]

Provides numerous options for setting the digital closed caption style in the sub-menu.

- **Caption Style:** Set to As Broadcaster or Custom mode. If Custom mode is selected, user can modify the detail styles described below. The setting result will be shown immediately on the bottom of the submenu OSD. Note: This feature is only available in Digital TV (ATSC) mode.
- **Font Size:** Selects this option to choose a caption display size according to your own preference. Select "Small", "Normal", or "Large".
- **Font Style:** Select digital closed caption font style.
- **Font Color:** Choose the caption display text color
- **Font Opacity:** Select the text opacity
- **Background Color:** Choose caption display character background color.
- **Background Opacity:** Choose one of the background opacity options.

- **Window Color:** Choose one of the display windows color.

- **Window Opacity:** Select one of the display windows color.

6. **Location**

Select from Store or Home mode. Store mode is recommended for displaying in a retail showroom, and Home mode is recommended for normal home use for Energy Saving.

7. **Version Info**

Display the software information.

8. **Reset**

Restore all the default Setup settings.

Parental Menu

User has to key in the four digit password before entering the Parental Control sub-menu. User can modify the restricted table after entering the parental sub-menu. While exiting the sub-menu, the parental control function is activated.

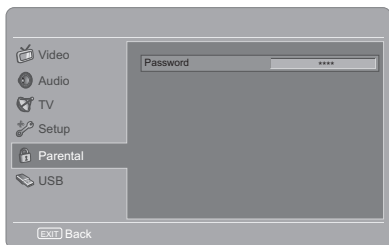

1. Password

Enter the password to access the parental sub menu.

Note:

- The default password is [0000].

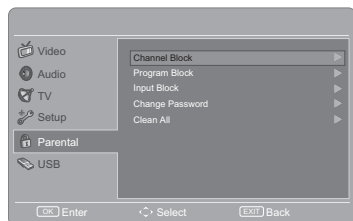

2. Channel Block

Prevents children from watching certain channels.

Note:

- If you access the blocked channel from the number buttons on the remote control, a prompting window appears asking for the password.

3. Program Block

Control access to specific programs based on the age and content ratings. The program content advisory data are provided by the broadcaster.

[Rating Enable]

Set to "On" to activate the program rating system.

[U.S. TV Ratings]

You set-top box or cable receiver box must be connected through RF or AV connectors to use U.S TV ratings function.

[U.S. Movie Ratings]

Control viewing of movies based on the Motion Picture Association of America (MPAA) rating.

[Canadian English Ratings]

Block the viewing movies by Canadian English ratings.

[Canadian French Ratings]

Block the viewing movies by Canadian French ratings.

[Open V-Chip]

Unlock the inhibitive channels or source signals.

[Block Unrated]

The unrated program will be blocked.

4. Input Block

Disable the specific external input source.

5. Change Password

Change the 4-digit parental control password.

6. Clean All

Clean all the parental ratings to default setting.

USB Menu

This feature is useful for viewing still pictures and listening to the music on USB Drives via the USB slot on the side your NEC display.

You can access the USB menu by pressing **Source** button on the remote control. This can also be accessed through the OSD main menu under the category "Multi-Media".

Note:

- Depending on the USB device, the TV may not be able to recognize the contained data.
- Use only alphanumeric characters for naming files.
- Do not disconnect a USB device or memory card from the TV while transferring files, using the slide show function, when a screen is switching to another or before you exit "USB" from the "Source" menu.
- Do not connect and disconnect a USB device from the TV repeatedly.

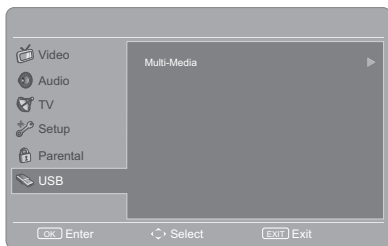

1. Basic Operation

Using the remote control's cursor, navigate through thumbnails to individually select pictures you would like to view.

Press **Source** button on the remote control and press **▲ ▼** to select **USB** input source and press **OK**. The USB thumbnail browser appears.

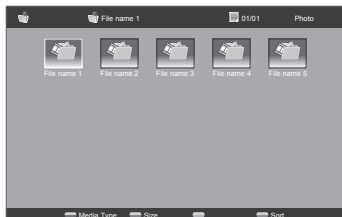

Press **Red button** to display the sub-menu. Select **Media Type** (Photo/Music) of the file you wish to play.

- Sort
- Media Type
- Thumbnail Size

Note:

- **Sort:** enables you to sort out the files in the selected **Media Type** category.
- **Thumbnail Size:** enables you to change the size of thumbnail.

2. View Photos

Use the navigation cursor to select the photo and press **OK** to view a full screen image.

- Buttons for enlarged photo display operation

Buttons	Descriptions
OK	Play or pause the slide show
CH +/-	Go to the previous/next photo in the same directory.
Red	Open the photo sub-menu
Green	Select the slide show duration.
Yellow	Select the slide show transition effect.
Exit	Return to the previous operation.

3. Play Music

Use the navigation cursor to select the file and press **OK** to play the music file.

- Buttons for audio mode

Buttons	Descriptions
▶	Fast forward the music.
◀	Rewind the music.
OK	Play or pause the music.
CH +/-	Go to the previous/next music.
Red	Open the music sub-menu.
Green	Play the music randomly.
Yellow	Audio only.
Blue	Show information of the music file.
Exit	Return to the previous operation.

4. USB device compatibility

USB 2.0 device	USB Memory (Mass Storage class)
File system	FAT / FAT32
Photo file format	JPEG (*.JPG)
Music file format	Bitrate: 32k, 64k, 96k, 128k, 196k, 256k, 320kbps Sampling frequency: 32k, 44.1k, 48kHz

Note:

- Progressive format jpeg files are not supported.
- All files in USB devices with capacity may not be played properly.
- Operation using USB hubs is not guaranteed.
- The external hard disc with capacity cannot be detected correctly.
- Cables used to extend the USB device must be certified as USB 2.0.

Tips

Care Of The Screen

Do not rub or strike the screen with anything hard as this may scratch, mar, or even damage the screen permanently. Unplug the power cord before cleaning the screen. Dust the display by wiping the screen and the cabinet with a soft, clean cloth. If the screen requires additional cleaning, use a clean, damp cloth. Do not use liquid cleaners, aerosol cleaners, or solvents of any kind.

Mobile Telephone Warning

Keep your mobile telephone away from your display to avoid disturbances in the picture or sound, possibly causing permanent damage to your display.

End Of Life Directives

In an effort to produce environmentally friendly products, your new display contains materials that can be recycled and reused. At the end of your displays life, specialized companies can minimize display waste by separating the reusable materials from non-reusable materials. Please ensure you dispose of your display according to local regulations.

License Notice and Trademark Acknowledgement



HDMI, the HDMI logo and High-Definition Multimedia Interface are trademarks or registered trademarks of HDMI Licensing LLC in the United States and other countries.



Manufactured under license from Dolby Laboratories. Dolby and the double-D symbol are trademarks of Dolby Laboratories.

Product Specification

This model complies with the specifications listed below.

Reorient or relocate the receiving display.

Designs and specifications are subject to change without notice.

This model may not be compatible with features and/or specifications that may be added in the future.

Model Name	E322	E422	E462	E552
DISPLAY				
Viewable	32"	42"	46"	55"
Television System	NTSC Standard, ATSC Standard (8-VSB, Clear-QAM)			
Channel Coverage	VHF: 2 through 13 UHF: 14 through 69 Cable TV: Mild band (A - 8 through A - 1, A through I), Super band (J through W), Hyper band (AA through ZZ, AAA, BBB), Ultra band (65 through 94, 100 through 125)			
CONNECTIONS				
Connectors	Rear			Downward
	AIR/CABLE HDMI 1, HDMI 2 SPDIF DIGITAL OUT PC IN: D-SUB and PC Audio COMPONENT and L/R Audio Input RS-232C			HDMI 1, HDMI 2, HDMI 3 PC IN: D-SUB and PC Audio RS-232C
	Side			
	HDMI 3 AV and L/R Audio Input Earphone Output USB/SERVICE PORT			SPDIF DIGITAL OUT AIR/CABLE COMPONENT /Video and L/R Audio Input
WEIGHT & DIMENSION				
Dimensions w/ Stand (W x H x D) (inch)	30.65 x 21.78 x 8.72	39.82 x 24.49 x 10.1	43.46 x 29.63 x 10.5	51.5 x 34.7 x 11.6
Dimensions w/o Stand (W x H x D) (inch)	30.65 x 20.04 x 3.15	39.82 x 25.59 x 3.58	43.46 x 27.60 x 3.7	51.5 x 32.9 x 4.6
Weight w/ Stand (lbs)	24.25	42.99	52.91	81.57
Weight w/o Stand and Base (lbs)	19.84	35.27	44.09	70.55
WALL MOUNTING				
VESA-compatible wall bracket (W x H)	200 x 200 mm	400 x 200 mm	400 x 200 mm	400 x 200 mm
Screw type	Metric 6 x 10 mm	Metric 6 x 10 mm	Metric 6 x 10 mm	Metric 6 x 10 mm

Model Name	E322	E422	E462	E552
POWER				
Power Consumption	105 W	180 W	188 W	365 W
Standby	< 1 W			
Power	AC 120V, 60Hz			
AUDIO POWER				
Power Consumption	2 x 5 W	2 x 10 W	2 x 10 W	2 x 10 W
OPERATING ENVIRONMENT				
Temperature	0°C — 40°C / 32°F — 104°F			
Humidity	10% — 85%			
Height	3000m			
STORAGE ENVIRONMENT				
Temperature	-10°C — 50°C / 14°F — 122°F			
Relative Humidity	5% — 85%			
Absolute Air Humidity	1—25 g/m ³			
Max. Change of Temp.	0.5°C/min (max. 10°C/30min)			
Air Pressure	700 — 1060 mbar (70—106Kpa)			
Radiation Solar Heat	700 W/m ²			
PACKAGE CONTENTS				
Supplied Accessories	1x TV Unit 1x Power Cord 1x D-sub Cable 1x Stand Base 1x Remote Control 2x 1.5V AAA Size Batteries 4x Stand Screws 1x User Manual			

All specifications, weights, and dimensions are subject to change without prior notice. Please access www.necdisplay.com for detailed specifications and dimensions for custom installations.

Before Calling Service

Please make these simple checks before calling service. These tips may save you time and money as charges for receiver installation and adjustments of customer controls are not covered under your warranty.

Symptoms	Items To Check And Actions To Follow
"Ghost " or double image when using the tuner	<ul style="list-style-type: none"> This may be caused by an obstruction to the antenna due to high rise buildings or hills. Using a highly directional antenna may improve the picture.
No power	<ul style="list-style-type: none"> Check to see if the display's AC power cord is plugged into the outlet. Unplug the display and after 60 seconds reinsert the plug into the outlet and power on the display.
No picture	<ul style="list-style-type: none"> At the rear of the display make sure the antenna connection is properly attached. Check to see if there is a station broadcast problem by trying multiple channels. Adjust the contrast and brightness settings. Check the Closed Caption settings as some text modes may block the visibility of the images on the display.
Good picture but no sound	<ul style="list-style-type: none"> Increase the VOLUME. Confirm that the display is not muted by pressing the MUTE button on the remote control.
Good sound but poor color	<ul style="list-style-type: none"> Adjust the contrast, color and brightness settings.
Poor picture	<ul style="list-style-type: none"> Poor picture quality may occur when an activated S-VHS camera or camcorder is connected to your display and another peripheral at the same time. Switch off one of the peripherals.
Snowy picture and noise when using the tuner	<ul style="list-style-type: none"> Check the antenna connection and signal.
Presence of a horizontal dotted line	<ul style="list-style-type: none"> This may be caused by electrical interference (e.g. hairdryer, nearby neon lights, etc.). Power cycle the equipment by turning off and then turning back on.
Display not responding via the remote control	<ul style="list-style-type: none"> Determine if the batteries are working and replace batteries if necessary. Clean the remote control sensor lens on the display. If necessary, utilize the buttons located on the side of the display. Select the TV mode to ensure your remote control is set in the TV mode.

Glossary

HDTV

HDTV displays are technically defined as being capable of displaying a minimum of 720p or 1080i active scan lines.

HDMI Inputs

High-Definition Multimedia Interface Audio / Video Inputs are located on the rear of the receiver. These connectors are used for the input of audio and video signals. Designed to receive higher picture resolution and offer sound connection options.

Menu

An on-screen listing of features shown on the display screen is made available for user adjustments.

MPAA

Motion Picture Association of America

Multichannel Television sound (MTS)

The broadcasting standard, which allows stereo sounds to be transmitted with the display picture.

RF

Radio Frequency or modulated signal design used by the carrier for television broadcasts.

Second Audio Program (SAP)

Another or additional audio channel provided for in the Multichannel Television Sound (MTS) broadcast standard. A monaural soundtrack included within the recorded or video signal (usually containing a second language translation for the displayed program).

Sleep Timer

You can set a time period for which the display will automatically turn off.

Limited Warranty

NEC Display Solutions of America, Inc. (hereinafter "NEC DISPLAY SOLUTIONS") warrants this Product to be free from defects in material and workmanship and, subject to the conditions set forth below, agrees to repair or replace (at NEC DISPLAY SOLUTIONS' sole option) any part of the enclosed unit which proves defective for a period of three (3) years from the date of first consumer purchase. Spare parts are warranted for ninety (90) days. Replacement parts of unit may be new or refurbished and will meet specifications of the original parts or unit. This warranty gives you specific legal rights and you may also have other rights, which vary from state to state, this warranty is limited to the original purchaser of the Product and is not transferable.

This warranty covers only NEC DISPLAY SOLUTIONS supplied components. Service required as a result of third party components is not covered under this warranty. In order to be covered under this warranty, the Product must have been purchased in the U.S.A. or Canada by the original purchaser. This warranty only covers Product distribution in the U.S.A. or Canada by NEC DISPLAY SOLUTIONS. No warranty service is provided outside of the U.S.A. or Canada, Proof of Purchase will be required by NEC DISPLAY SOLUTIONS to substantiate date of purchase. Such proof of purchase must be an original bill of sale or receipt containing name and address of seller, purchaser, and the serial number of the product.

It shall be your obligation and expense to have the Product shipped, freight prepaid, or delivered to the authorized reseller from whom it was purchased or other facility authorized by NEC DISPLAY SOLUTIONS to render the services provided hereunder in either the original package or a similar package affording an equal degree of protection. All Products returned to NEC DISPLAY SOLUTIONS for service MUST have prior approval, which may be obtained by calling 1-800-632-4662. The Product shall not have been previously altered, repaired, or serviced by anyone other than a service facility authorized by NEC DISPLAY SOLUTIONS to render such service. The serial number of the product shall not have been altered or removed. In order to be covered by this warranty the Product shall not have been subjected to displaying of fixed images for long periods of time resulting in image persistence (afterimage effects), accident, misuse or abuse or operated contrary to the instructions contained in the User's Manual. Any such conditions will void this warranty.

NEC DISPLAY SOLUTIONS SHALL NOT BE LIABLE FOR DIRECT, INDIRECT, INCIDENTAL, CONSEQUENTIAL, OR OTHER TYPES OF DAMAGES RESULTING FROM THE USE OF ANY NEC DISPLAY SOLUTIONS PRODUCT OTHER THAN THE LIABILITY STATED ABOVE. THESE WARRANTIES ARE IN LIEU OF ALL OTHER WARRANTIES EXPRESS OR IMPLIED, INCLUDING, BUT NOT LIMITED TO, THE IMPLIED WARRANTIES OF MERCHANTABILITY OR FITNESS FOR A PARTICULAR PURPOSE. SOME STATES DO NOT ALLOW THE EXCLUSION OF IMPLIED WARRANTIES OR THE LIMITATION OR EXCLUSION OF LIABILITY FOR INCIDENTAL OR CONSEQUENTIAL DAMAGES SO THE ABOVE EXCLUSIONS OR LIMITATIONS MAY NOT APPLY TO YOU.

This Product is warranted in accordance with the terms of this limited warranty. Consumers are cautioned that Product performance is affected by system configuration, software, the application, customer data, and operator control of the system, among other factors. While NEC DISPLAY SOLUTIONS Products are considered to be compatible with many systems, specific functional implementation by the customers of the Product may vary. Therefore, suitability of a Product for a specific purpose or application must be determined by consumer and is not warranted by NEC DISPLAY SOLUTIONS.

For the name of your nearest authorized NEC Display Solutions of America, Inc. service facility, contact NEC Display Solutions of America, Inc. at 1-800-632-4662.

References

NEC Monitor Customer Service & Support

Customer Service and Technical Support

Parts and Accessories (800) 632-4662

(888) 634-4662 Fax (800) 695-3044

Warranty Information

www.necdisplay.com

Online Technical Support

www.necdisplay.com

Sales and Product Information

Sales information Line

(888) 632-6487

Canadian Customers

(866) 771-0266, Ext#: 4037

Government Sales

(800) 284-6320

Government Sales email

gov@necdisplay.com

Electronic Channels

<http://www.necdisplay.com>

Product Registration

<http://www.necdisplay.com>

Drivers and Downloads

<http://www.necdisplay.com>

